

Diagnosis Communication Module

Series 9415



www.stahl.de



14240E00

- > For FOUNDATION™ fieldbus H1
- > Transmission of diagnostic data from up to 8 FF H1 segments
- > Diagnosis of the physical layer values: voltage / current, jitter, noise, signal level, unbalance
- > Simple integration into asset management systems via FF H1 and EDD
- > Diagnostics handling acc. to NAMUR NE 107 and FF-912
- > LEDs for diagnostics and operation
- > Various bus-Carriers for 4 and 8 segments, simplex and redundant available



A5



The Diagnosis Communication Module (DCM) 9415 transmits fieldbus diagnostics data, measured by the Fieldbus Power Supply 9412, via FOUNDATION™ fieldbus H1 to a host and / or asset management system.

The Fieldbus Power Supplies are continuously measuring all the relevant physical layer values acc. to NAMUR NE 123.

The DCM collects the values from up to 8 segments and transmits the diagnostics information via one of the installed FF H1 segments or alternatively via a dedicated diagnostic segment.

The integration into host and asset management tools is done via an EDD, offering sophisticated possibilities for setting alarm and pre-alarm levels, obtaining life maintenance data from the bus and creating detailed reports.

Zone	ATEX / IECEx					
	0	1	2	20	21	22
Ex interface			x			
Installation in			x			

WebCode 9415A

Diagnosis Communication Module

Series 9415



Selection Table

Version	Description	Order number
Diagnosis communication module	transmission of diagnostics data from up to 8 via FF H1	9415/00-310-42
Note	installation in bus-Carriers with 8 (simplex / redundant) or 16 (redundant) slots	

Explosion Protection

Global (IECEX)

Gas	IECEX BVS 11.0054x Ex nA [ic] IIC T4 Gc
-----	--

Europe (ATEX)

Gas	BVS 11 ATEX E 104X ⊕ II 3 G Ex nA [ic] IIC T4 Gc
-----	---

Certificates and Approvals

Certificates	ATEX, IECEX
--------------	-------------

Further parameters

Installation	in Zone 2, Div. 2 and in the safe area
--------------	--

Safety data

Max. permissible voltage U_i	32 V
Internal capacitance C_i	negligible
Internal inductance L_i	10 μ H

Technical Data

Electrical data

Power supply	
Connection	from the bus-Carriers Series 9419
Nominal voltage U_N	24 V DC
Voltage range	18 ... 32 V DC
Current consumption	40 mA at 24 V DC
Galvanic isolation	
Fieldbus to Power Supply	1500 V AC (test voltage)

Indication

Indication	LED "PWR", green
Function Indication	LED "ERR", red (flashes = DCM maintenance required, ON = failure DCM)
Segment status	LED "ERR", red (flashes = segment maintenance required, ON = failure segment)

Diagnostics interface

For connection to	ISbus Fieldbus Power Supplies 9412 (via bus-Carrier 9419)
Physical layer measurement (acc. to NAMUR NE 123)	via Fieldbus Power Supplies 9412: Segment: voltage / current, jitter, signal level, noise, balance, current and voltage Fieldbus devices: jitter, signal level
Further Data	Serial number, type, version revision for DCM, Fieldbus Power Supplies and bus-Carrier.

Fieldbus interface

For connection to Specification	Host and Asset Management Systems with H1 interface FOUNDATION™ fieldbus H1 (IEC 61158-2)
Data transmission	Via segment 1 ... 4 / 8 (depends on bus-Carrier), selectable Alternative: via dedicated diagnosis segment
Voltage range	9 ... 32 V DC
Current consumption	13 mA

Functions

FF stack	Softing
Technology	EDD
Parameter data	Resource Block for device data DCM, Fieldbus Power Supply and bus-Carrier
Cyclic data transmission	10 DI function blocks for status information / common error per segment
Acyclic data transmission	9 Transducer blocks for detailed information: physical layer values, HI-alarm, HIHI-alarm, LO-alarm, LOLO-alarm, status DCM, status segment, status fieldbus devices
Alerts and status	FF H1 events acc. to FF-912 / NAMUR NE 107 (Field Diagnostics Alarms)
Firmware update	RS232 via PC

Technical Data

Ambient conditions

Ambient temperature - 20 ... + 70 °C
Storage temperature - 40 ... + 80 °C
Relative humidity (no condensation) < 95 %

Electromagnetic compatibility
Tested to the following standards and regulations:
EN 61326 (IEC/EN 61000-4-1...6 und 11), NAMUR NE 21

Electrical connection

Connection diagram

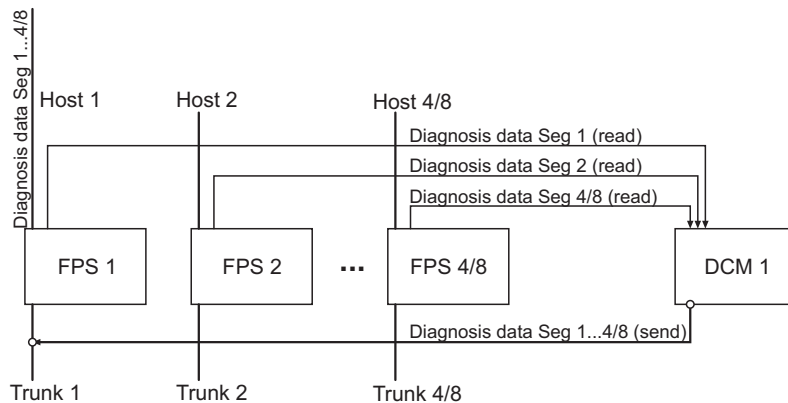

Data transmission via segments 1 ... 4 / 8

14711E02

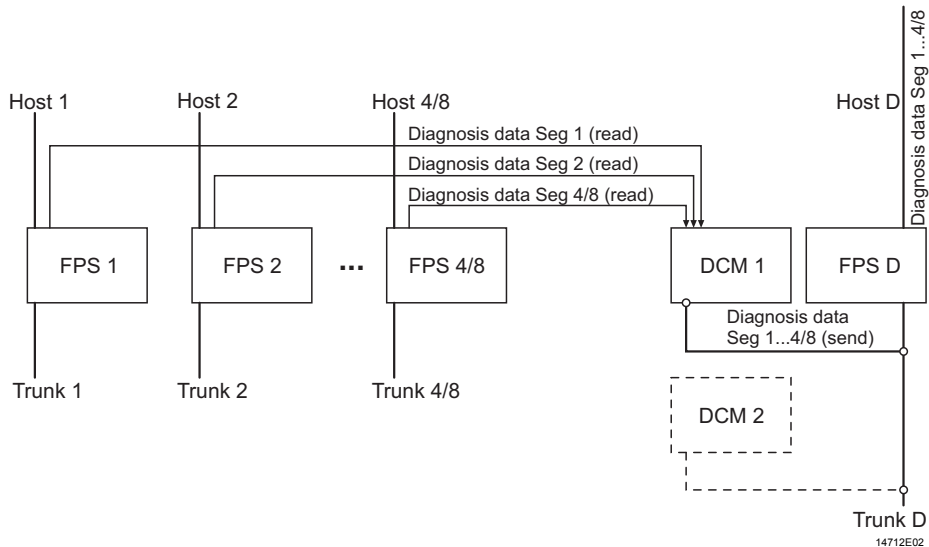

Data transmission via diagnosis segment (optional)

14712E02

Mechanical data

Terminals

	one wire	two wires
	Screw terminals	Screw terminals
rigid	0.2 ... 2.5 mm ²	0.2 ... 1 mm ²
flexible	0.2 ... 2.5 mm ²	0.2 ... 1,5 mm ²
flexible, end covering sleeves	0.25 ... 2.5 mm ²	0.25 ... 1 mm ²

Assembly

in bus-Carrier Series 9419

Installation position

vertical or horizontal

Degree of protection

Enclosure

IP30

Terminals

IP20

Enclosure material

PA 6.6





Fire protection class (UL-94)

V0

Connecting cable

26 poles, for connection DCM with bus-Carrier

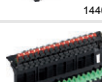
Accessories and Spare Parts

Designation	Illustration	Description	Art. no.
Fieldbus Power Supply	 12783E00	Fieldbus power supply and diagnosis	200586
	 12809E00	Fieldbus power supply, diagnosis and adjustable warning level	200588
bus-Carrier	 14402E00	bus-Carrier for 4 segments, redundant	208746
	 14403E00	bus-Carrier for 8 segments, simplex	208745
	 14403E00	bus-Carrier for 8 segments, redundant	208747

We reserve the right to make alterations to the technical data, dimensions, weights, designs and products available without notice. The illustrations cannot be considered binding.