

MMU 29

Locknut, brass nickel-plated, Pg29

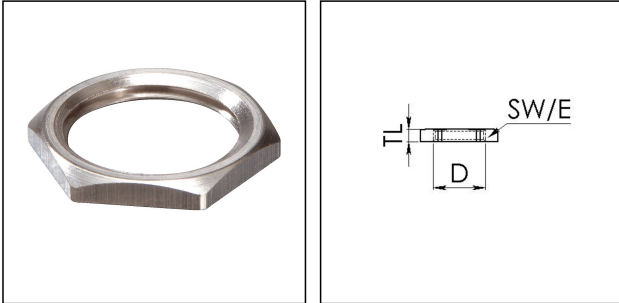

Products may differ in size, colour and appearance to those shown. If you require further information or customisation, please contact us directly.



Material	Brass nickel-plated
Surface	Nickel-plated
Temp. range min	-200 °C
Temp. range max	250 °C
Thread type	PG
Ø Connection thread D	29
Key width SW	41 mm
Collar diameter (E)	45 mm
Total length TL	4 mm
Order no. nickel-plated	10062147
Type	MMU 29
Packing unit	100
ETIM-Classification	EC000940

28.11.2019

Your Contact:

WISKA Hoppmann GmbH

Kisdorfer Weg 28 · 24568 Kaltenkirchen · Germany

☎ +49-4191-508-0 · 📠 +49-4191-508-209

contact@wiska.de · www.wiska.com



Your Contact:

WISKA Hoppmann GmbH

Kisdorfer Weg 28 · 24568 Kaltenkirchen · Germany

☎ +49-4191-508-0 · 📠 +49-4191-508-209

contact@wiska.de · www.wiska.com